

SMD-200



Rectifier Diode



Type	V_{RRM}	$I_{FAVM} (T_c, ^\circ C)$	I_{FRMS}	I_{FSM}	i^2t	V_{FM}	I_{FM}	V_{FO}	r_F	T_{VJM}	R_{thJC}
	V	A	A	A	kA ² s	V	A	V	m Ω	$^\circ C$	K/W
SMD-200	300-3600	200 (125)	310	5500	151	1.25	600	0.90	0.8	150	0.20

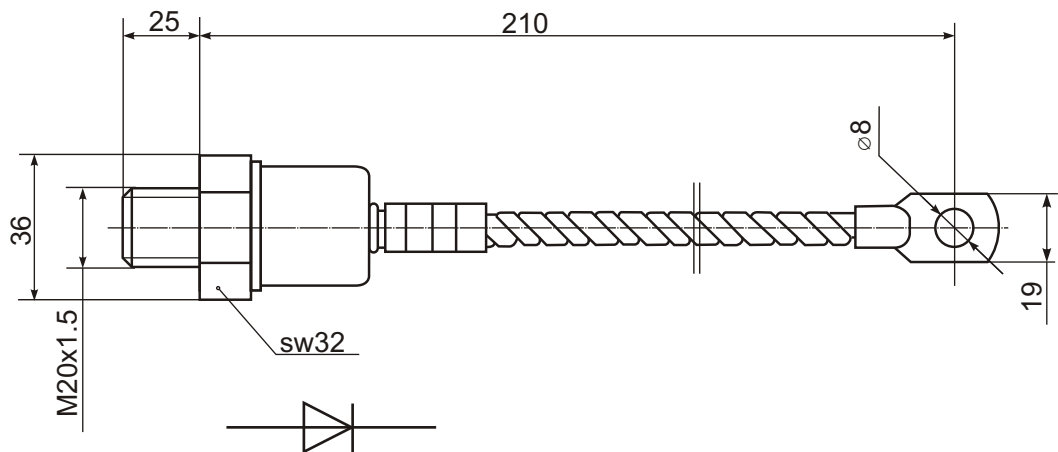

Features:

- Hermetic metal case with ceramic insulator
- Capacity of supporting high surge current
- International standard case

Typical Applications:

- AC/DC converters
- DC power supplies
- Machine tool controls